

OVERVIEW

HDMV-8X V2 is a powerful 8-Port HDMI Multiviewer and KVM Switch that allows users to monitor and control up to 8 computers simultaneously on a single display. With ultra-clear 4K output, seamless switching, and a variety of multiview modes, the HDMV-8X V2 is ideal for control rooms, command centers, and high-density workstation environments.

It supports multiple display modes including full screen, quad, dual, 2x4, and picture-in-picture (PIP), with independent keyboard/mouse, USB, and audio control per channel. Integrated front panel, hotkey, and RS-232 control make it easy to operate in any setup.

APPLICATION DIAGRAM

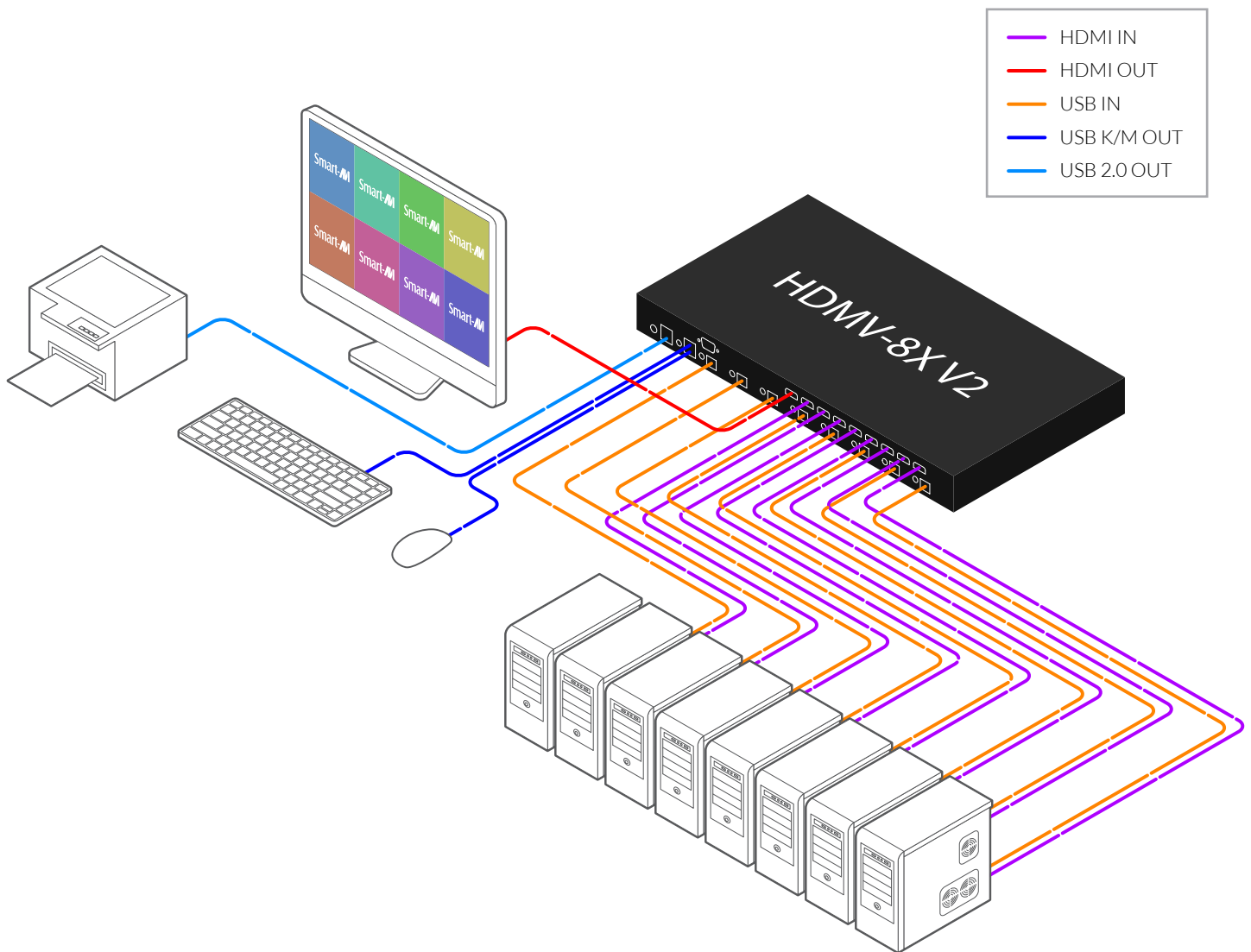

SCREEN MODES



Full Screen Mode

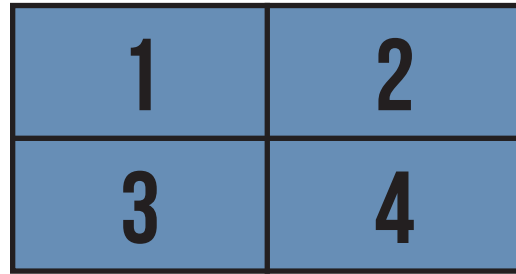

Quad Mode



Dual Mode

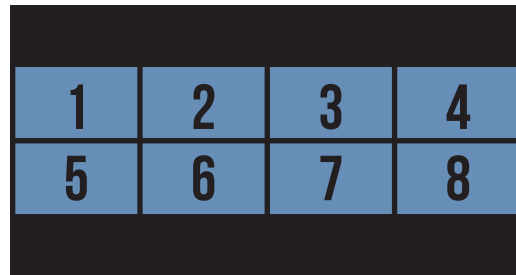

2X4 Mode

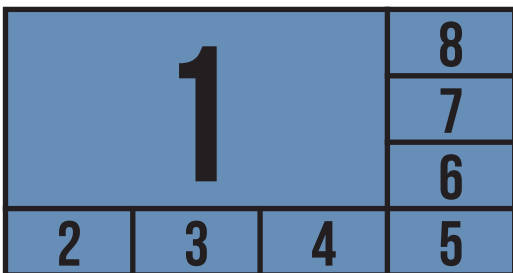

Full Screen with PIP Mode

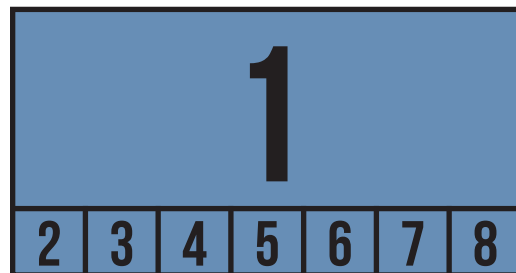

Full Screen with Bottom PIP Mode

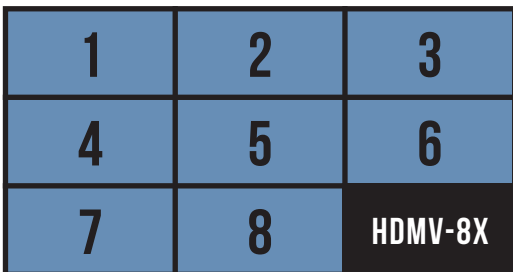

8X Mode

FRONT AND BACK

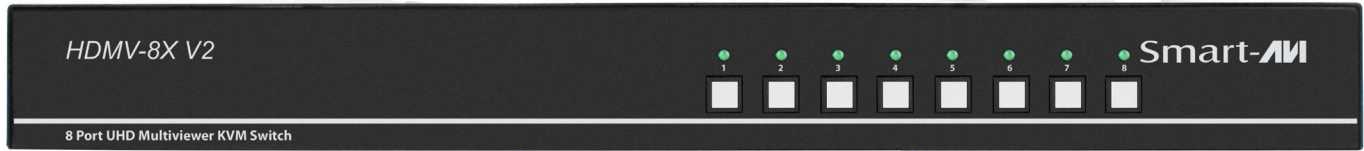

Front Panel



Back Panel

TECHNICAL SPECIFICATIONS

VIDEO	
Video Bandwidth	Single-link 340MHz [10.2Gbps]
Resolution	Up to 4K (3840 x 2160) @ 30 Hz
Input Video Signal	1.2 volts
Input DDC Signal	5 volts
Single Link Range	1080p
Format	HDMI 1.4
DVI Compliance	Single-link DVI-D 2.0
HDCP Compliance	1.0/2.0
Input Interface	(4) HDMI
Output Interface	HDMI
Connector	Type A [19-pin female]

USB	
Input	USB 2.0, 1.1, and 1.0
Input Interface	(4) USB Type B
Input	USB 2.0, 1.1, and 1.0
CONTROL	
Front Panel	USB 2.0, 1.1, and 1.0
RS-232	DB9 (female)
Max. Baud Rate	9600 bps
OTHER	
Power	Internal 100-240 VAC
Dimensions	17" W x 1.7" H x 10.2" D
Weight	4.05 lbs
Approvals	UL, CE, ROHS Compliant
Operating Temperature	+23 to +95°F (-5 to +35°C)
Storage Temperature	-4 to 185°F (-20 to 85°C)
Relative Humidity	Up to 90% (No Condensation)

PART NO.	DESCRIPTION
HDMV-8X-S	8 Port UHD Multiviewer KVM Switch. Includes: [HDMV-8X & Power Cord]